

野外騎乗に使用する全図

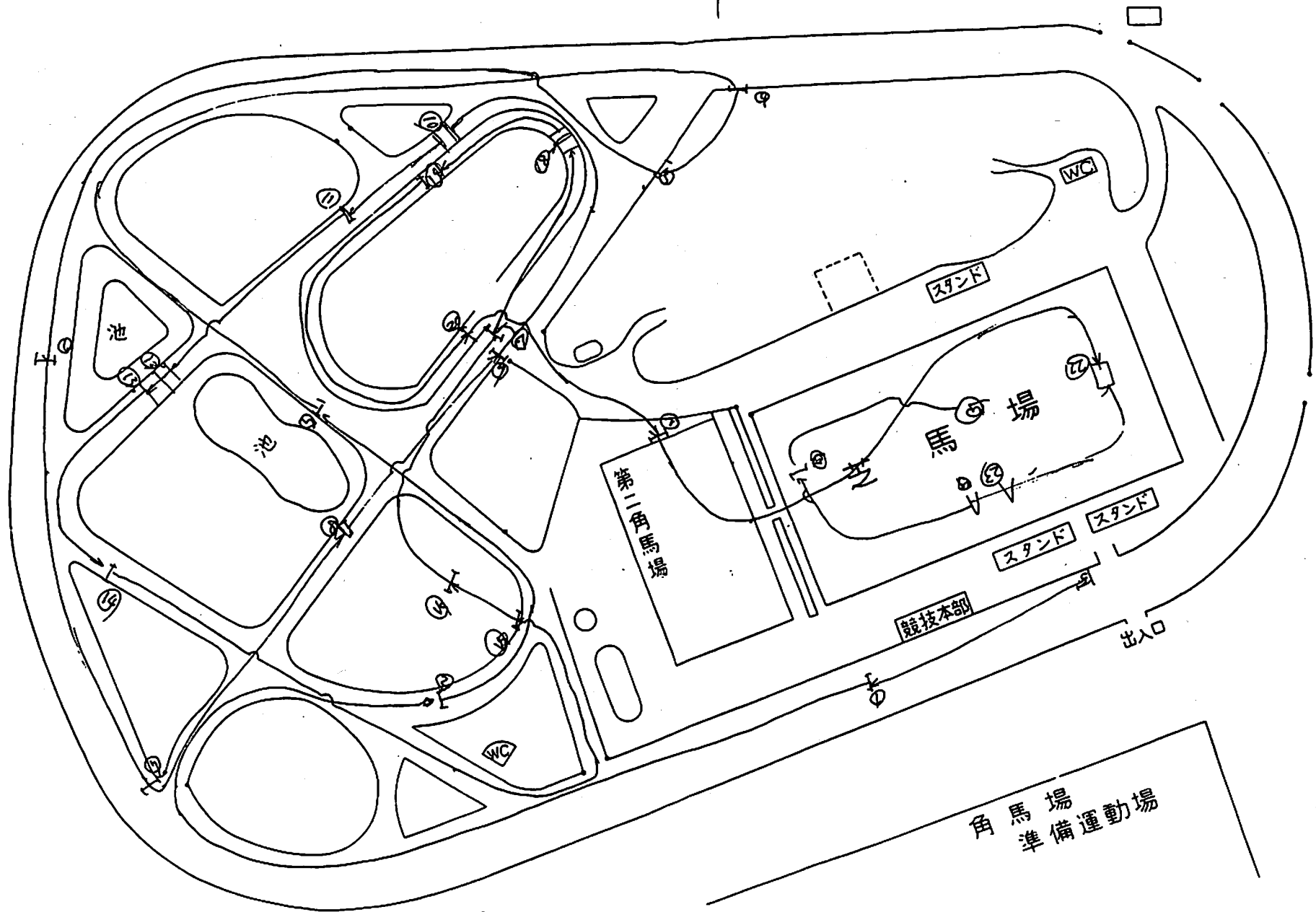

1. グラス降巻



2. 電柱ナター

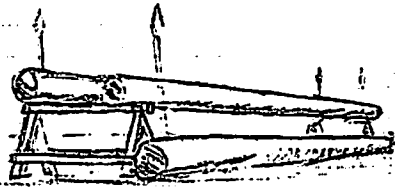

7. 電柱・73降巻 A.B.C

3. 電柱バケット

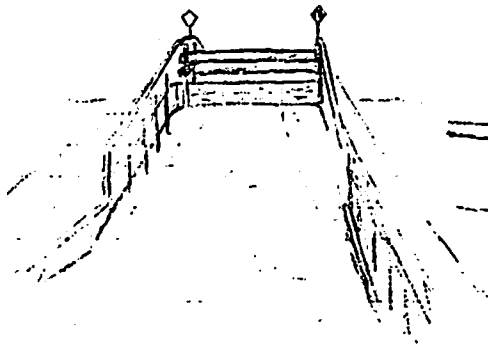

4. 山形三段

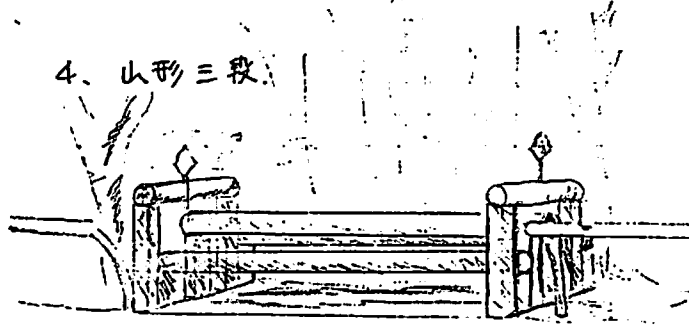

5. バケット 又は 重直

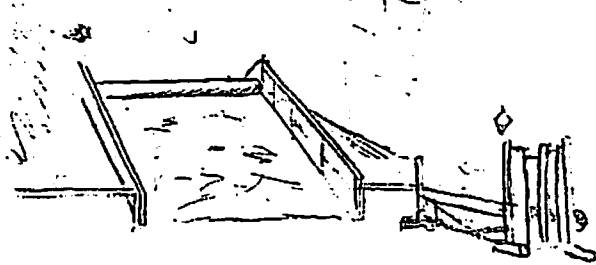

6. グラス降巻

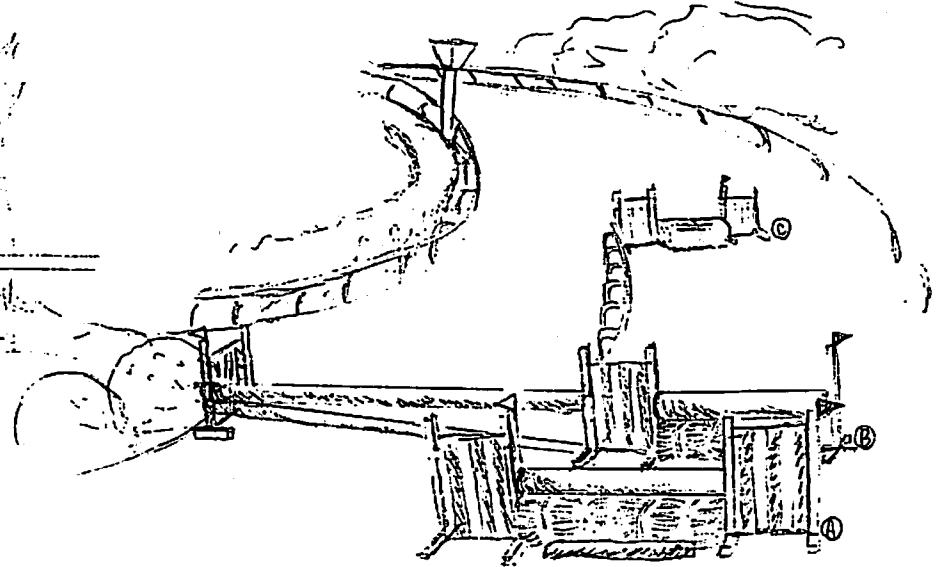
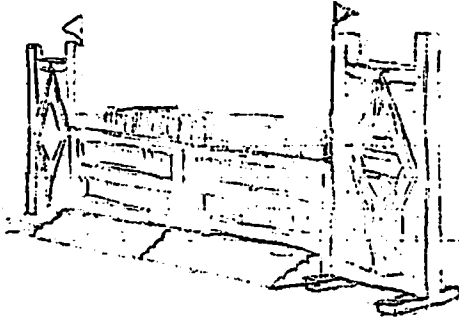

8. 大乾塚

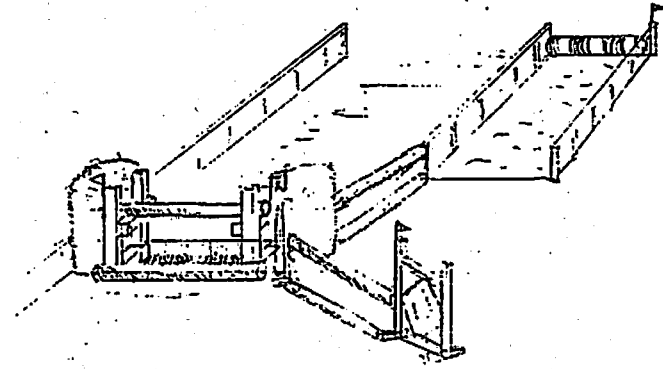

11. スキ-シャ-ンフ

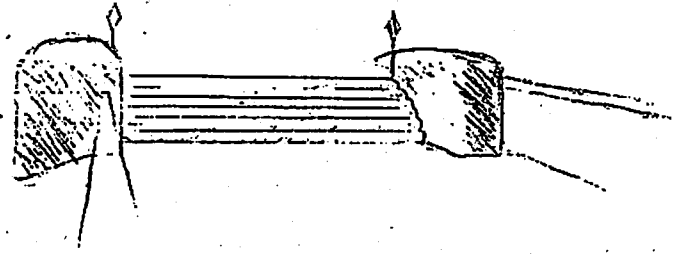

9. 生垣

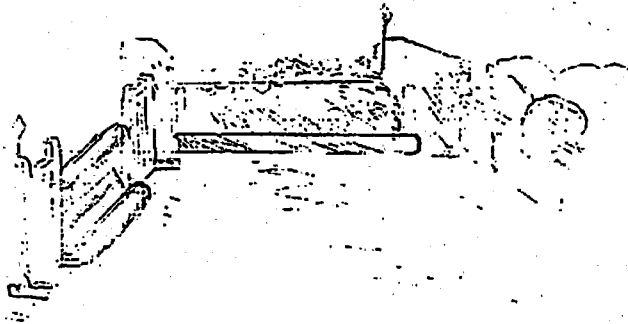

10. バウ-ス

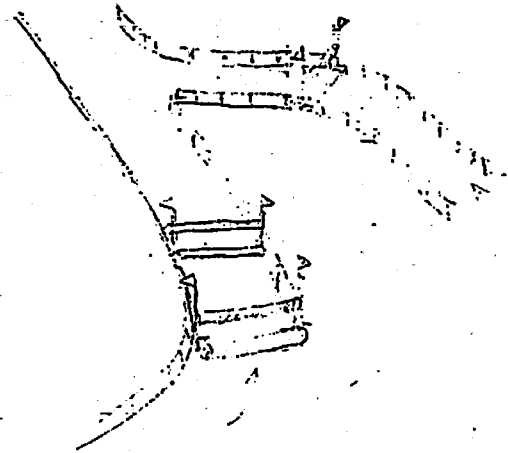

12. 飛心込水塚 A B

13. レ-カ

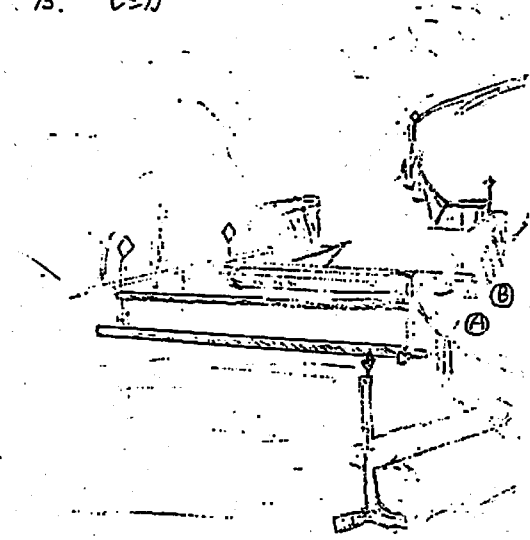

14. ピアパンケツ・電柱 ABCD

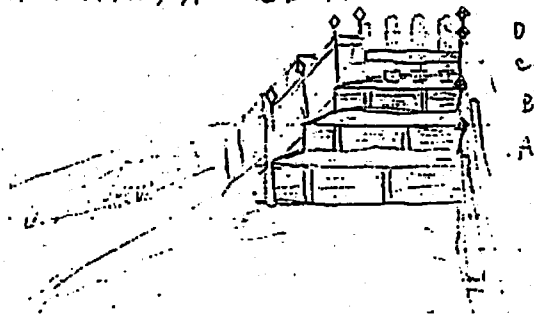

17. 電柱ノワザ

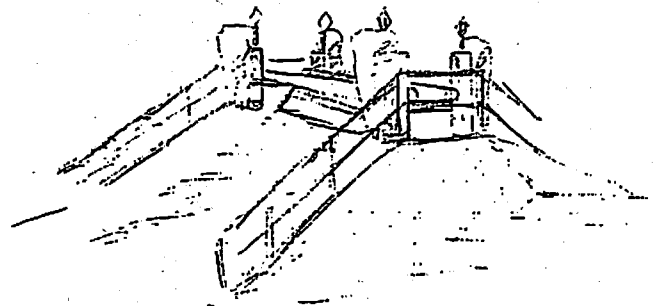

18. タラシパンケツ

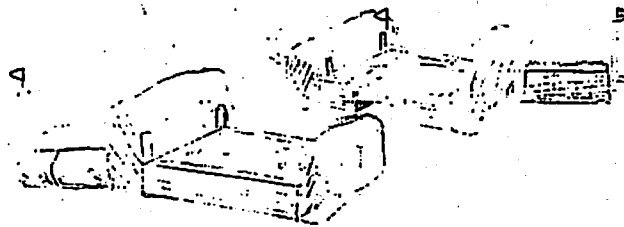

15. スキージャンプ



20. ジタン AB

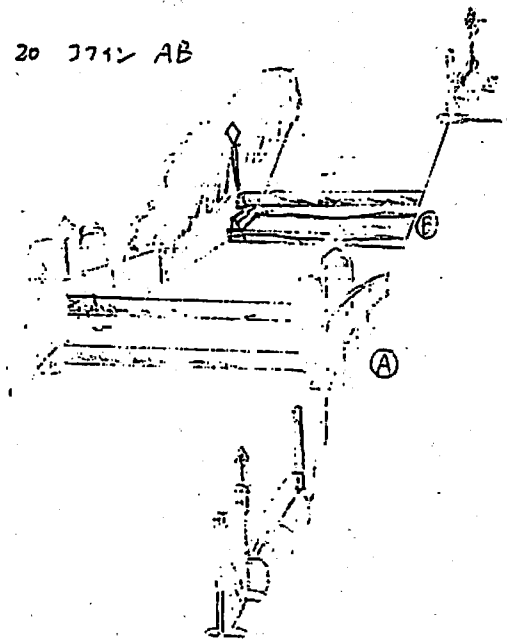

19. 乾家

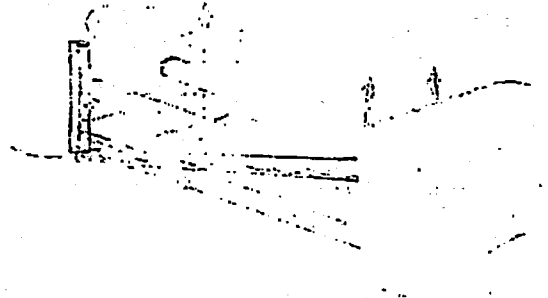

16. 花投

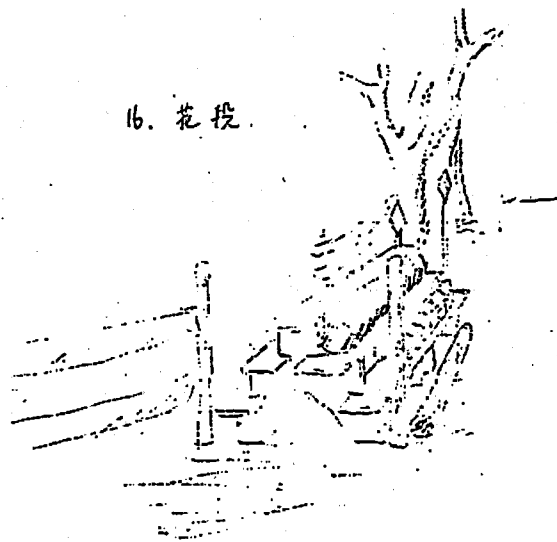

21. フルピンチ

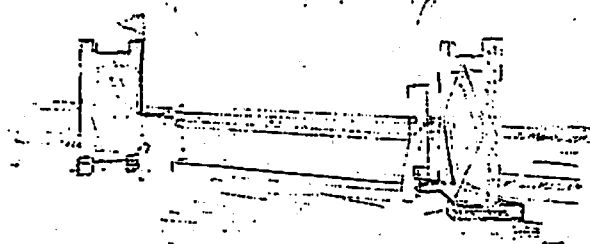

22. バンケット

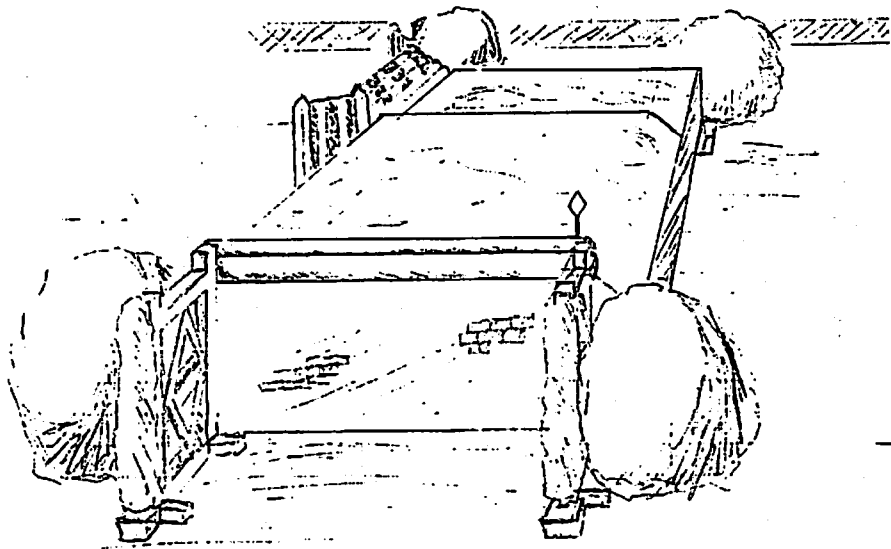

25. トウケ-ネ ヌロ ビヤダル.

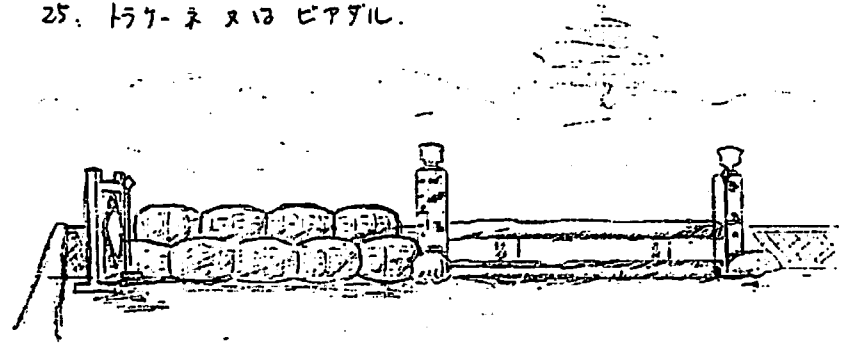

23, 24. V字 障子.

